

■ WARNING

PARTS LIST

■ ELECTRICAL PARTS

Components having special characteristics are marked  and must be replaced with parts having specifications equal to those originally installed. Carbon resistors 1/4 W are not included in the ELECTRICAL PARTS list. For the parts No. of the carbon resistor, refer to P. 27.

Ref. No.	Part No.	Description	部 品 名	Remarks	Common Model	Markets	ランク
	NA 09 42 80	Main Circuit Board	メ イ ン シ ー ト			R	
	NA 09 42 90	"	"			U,C	
	NA 09 43 00	"	"			A	
	NA 09 43 10	"	"			G,B	
	FC 44 44 70	Mylar Cap.	マ イ ラ ー コ ン	C349, 350			
	Fi 38 41 00	Ceramic Cap.	セ ラ コ ン	C374 Inter-			
	Fi 50 41 00	"	"	" changeable			
	FG 21 05 00	"	"	C313, 314			
	FG 71 11 00	"	"	C335, 336			
	FG 21 13 90	"	"	C343, 344			
	FG 21 21 50	"	"	C377, 378		A,G,B	
	FG 21 22 20	"	"	C323, 324			
	FU 35 12 20	Mica Cap.	マ イ カ コ ン	C339~342			
*	VC 69 22 00	Electrolytic Cap.	ケ ミ コ ン	C365, 366			
	FZ 00 46 60	MM Cap.	M M コ ン	C367			
	FZ 00 46 60	"	"	C370		R,U,C	
	FZ 00 46 60	"	"	C361, 368, 369, 373		A,G,B	
	FZ 00 46 80	Electrolytic Cap.	ケ ミ コ ン	C331, 332			
	FZ 00 74 10	"	ブ ラ ッ ク ゲ ー ト コ ン	C371, 372			
	FZ 00 54 10	"	"	C337, 338			
	FZ 00 61 30	"	"	C311, 312			
	FA 15 31 20	Mylar Cap.	マ イ ラ ー コ ン	C325, 326			
	FA 15 32 20	"	"	C309, 310			
	FA 15 35 60	"	"	C327, 328			
	FA 15 41 00	"	"	C353~358		A,G,B	
	FA 15 42 70	"	"	C329, 330			
	FA 15 43 90	"	"	C319, 320			
	FA 15 51 20	"	"	C321, 322			
	UJ 11 81 00	Electrolytic Cap.	ケ ミ コ ン	C315~318			
	FJ 14 82 20	"	"	C364			
	UW 83 71 00	"	"	C305, 306			
	UW 83 72 20	"	"	C363			
	UJ 13 74 70	"	"	C303, 304			
	UJ 13 81 00	"	"	C345, 346, 362			
	UW 84 71 00	"	"	C375			
	UJ 15 82 20	"	"	C333, 334			
	UW 56 53 30	"	"	C359			
	UJ 16 64 70	"	"	C360			
	UT 45 44 70	Polypropylene Film Cap.	ポ リ プ ロ コ ン	C347, 348, 351, 352			
	UT 45 22 20	"	"	C301, 302, 307, 308			
	VC 79 37 00	Coil	空 心 コ イ ル	L301, 302			
	HV 45 52 20	Flame Proof Carbon Resistor	不 燃 化 カ ー ボ ン 抵 抗	R317~320			
	HV 45 31 00	"	"	R435, 436			
	HV 45 34 70	"	"	R377~380 391, 392, 432, 443, 444			
	HV 45 41 00	"	"	R399, 400			
	HV 45 42 20	"	"	R365, 366			
	HV 45 51 00	"	"	R363, 364, 375, 376			
	HV 45 51 80	"	"	R321, 322			
	HV 45 55 60	"	"	R361, 362			
	HV 45 61 00	"	"	R353~356			

* New Parts (新規部品)

AX-700/700U

Ref. No.	Part No.	Description			部 品 名	Remarks	Common Model	Markets	ランク
	HV 45 61 20	Flame Proof Carbon Resistor	1.2kΩ	1/4W	不燃化カーボン抵抗	R371~374, 393, 394			
	HV 45 62 20	"	2.2kΩ	1/4W	"	R357, 358, 367~370			
	HV 45 65 60	"	5.6kΩ	1/4W	"	R389, 390			
	HL 31 44 70	Metal Oxide Film Resistor	47Ω	1W	酸 金 抵 抗	R433, 434			
	HL 32 34 70	"	4.7Ω	2W	"	R445, 446			
	HL 32 52 70	"	270Ω	2W	"	R397, 398			
	HL 42 63 30	"	3.3kΩ	2W	"	R426, 427			
※	HL 93 22 20	"	0.22Ω	3W	"	R381~388			
	VA 78 76 00	Pre-Set Potentiometer	B1kΩ		半 固 定 抵 抗 器	VR301, 302			
	VB 14 07 00	"	B1kΩ		"	"			
※	VC 23 68 00	Potentiometer	40kΩ×2		可 変 抵 抗 器	VR303 BASS			
※	VC 23 69 00	"	100kΩ×2		"	VR304 TREBLE			
	iA 09 70 00	Transistor	2SA970(GR, BL)		ト ラ ン ジ ス タ ー	Q301~304, 321, 322 337, 343			
	iA 10 15 21	"	2SA1015(Y)		"	Q313, 314			
	iC 18 15 20	"	2SC1815(Y)		"	Q307, 308, 342			
	iC 22 40 00	"	2SC2240(GR, BL)		"	Q305, 306, 317~320 335, 336, 338~341			
	iC 27 05 00	"	2SC2705(O, Y)		"	Q309, 310			
	iX 60 42 00	"	2SC2878(A, B)		"	Q311, 312			
	iF 00 06 70	Diode	1S2473		ダ イ オ ード	D301~308 311~313 Inter-			
	iF 00 00 40	"	1S1555		"	" changeable			
	iF 00 14 00	"	1SS82		"	D309, 310, 317			
	iF 00 19 40	Zener Diode	HZ24-2		ツェナーダイオード	D314			
	iF 00 20 80	"	HZ16-3L		"	D322, 323			
	iF 00 42 70	LED	SLR-55URC3H		L E D	D315			
	iH 00 11 60	Diode, Bridge	4D4B41		ダイオードブリッジ	D316			
	iF 00 84 80	Diode	1SR35-100A		ダ イ オ ード	D318~321			
	KA 80 35 70	Push Switch	2-2NS		プッシュスイッチ	SW302 Speaker			
※	VC 23 49 00	Power Switch	TV-5		パワースイッチ	SW303 Power			
※	VC 37 81 00	Push Switch	2-2S		プッシュスイッチ	SW301 Tone Bypass			
	KB 00 04 00	Fuse	T5.0A 250V		ヒューズタイラッシュ	F302		R	
	KB 00 07 90	"	T4.0A 250V		ヒューズタイムラグ	F301		A, G, B	
※	KB 00 13 90	"	10A 250V		U L ヒューズ	"		U, C	
	KB 00 14 90	"	10A 250V		ヒューズ	"		R	
	VC 27 86 00	Relay	G5R-2232PDC24V		リ レ ー	RY301			
	KC 00 19 40	"	DH24D2-OTM		"	" Inter-			
	KC 00 20 00	"	JR2A-DC24V		"	" changeable			
	LB 30 17 20	Jack			ホ ー ン ジャック	JK301			
※	VD 26 28 00	Slide SW Ass'y			スライドスイッチ Ass'y	Voltage Selector		G, B	
	LA 00 21 40	Lapping Terminal	P=10	i-Type	i型ラッピング端子板				
※	VC 31 36 00	Speakers Terminal	8P		スピーカーターミナル			R, U, A, C	
※	VC 72 08 00	"	8P		"			G, B	

※New Parts (新規部品)

AX-700/700U

Ref. No.	Part No.	Description	部品名	Remarks	Common Model	Markets	ランク
	LB 20 10 60	Fuse Holder Pin	YSH403T	ヒューズホルダーピン		A,G,B	
	LB 20 19 70	"	23165081	"		R,U,C	
	LB 60 42 80	AC Outlet	3P	A C アウトレット		R	
	LB 60 81 70	"	3P	"		U,C	
	CB 64 46 70	Cover, Capacitor		コンデンサーカバー		G,B	
	VA 72 53 00	Parallel Holder	3P	バラレルホルダー			
	VA 72 57 00	"	7P	"			
	VB 23 00 00	Wire Trap	9P	ワイヤートラップ			
	BB 06 95 10	GND Metal		ランド金具			
	VA 82 15 00	Radiator		ラジエター		U,C	
	EZ 00 13 50	Cup Tight Screw	3X14 FCRM3-BI	カップタイトネジ		U,C	
	NA 09 43 20	Function Circuit Board		ファンクションシート		R,U,A,C	
	NA 09 43 30	"		"		G,B	
	FZ 00 65 40	Mylar Cap.	0.01μF 50V	マイラーコン	C105,106		
	FG 21 22 20	Ceramic Cap.	220pF 50V	セラコン	C127~138, 145~148	G,B	
	FG 41 24 70	"	470pF 50V	"	C139~144, 162, 163	G,B	
	FG 24 41 00	"	0.01μF 50V	"	C161	G,B	
※	VC 78 07 00	Electrolytic Cap.	1000μF 25V	ケミコン	C125,126		
※	UA 25 24 70	Mylar Cap.	470pF 50V	マイラーコン	C153,154		
	UA 25 31 50	"	1500pF 50V	"	C111,112	R,U,A,C	
	FA 15 32 70	"	2700pF 50V	"	"	G,B	
	UA 25 35 60	"	5600pF 50V	"	C123,124		
	FA 15 41 80	"	0.018μF 50V	"	C121,122		
	UA 25 43 30	"	0.033μF 50V	"	C149,150		
	UA 25 44 70	"	0.047μF 50V	"	C155~158		
	UI 33 71 00	Electrolytic Cap.	10μF 16V	ケミコン	C107,108,159,160		
	UW 56 53 30	"	0.33μF 50V	"	C151,152		
	UI 91 92 20	"	2200μF 6.3V	"	C113,114		
	UK 13 72 20	"	22μF 16V	B P ケミコン	C119,120		
	UT 46 41 10	Polypropylene Film Cap.	0.011μF 100V	ポリプロコン	C117,118		
	UT 46 43 90	"	0.039μF 100V	"	C115,116		
	UT 45 22 20	"	220pF 100V	"	C109,110		
	UT 45 21 50	"	150pF 100V	"	C101,102	G,B	
	VA 98 35 00	Coil	15μH	コイル	L101,102	G,B	
※	VC 40 73 00	"	470μH	"	L103,104	G,B	
	HF 85 41 00	Carbon Film Resistor	10Ω 1/6W	カーボン抵抗	R127,128		
	HF 85 34 70	"	4.7Ω 1/6W	"	R181	G,B	
	HF 85 42 20	"	22Ω 1/6W	"	R173,174	G,B	
	HF 85 43 30	"	33Ω 1/6W	"	R105,106	R,U,A,C	
	HF 85 64 70	"	4.7kΩ 1/6W	"	"	G,B	
	HF 85 51 00	"	100Ω 1/6W	"	R119,120	R,U,A,C	
	HF 85 51 80	"	180Ω 1/6W	"	R119,120	G,B	
	HF 85 51 50	"	150Ω 1/6W	"	R121,122,129,130		

※New Parts (新規部品)

Ref. No.	Part No.	Description	部品名	Remarks	Common Model	Markets	ランク
	HF 85 52 20	Carbon Film Resistor	220Ω 1/6W	カーボン抵抗	R141~156, 175~180, 183, 184	G,B	
	HF 85 52 20	"	220Ω 1/6W	"	R107,108		
	HF 85 54 70	"	470Ω 1/6W	"	R131,132,165,166		
	HF 85 61 00	"	1kΩ 1/6W	"	R169,170		
	HF 85 61 20	"	1.2kΩ 1/6W	"	R137		
	HF 85 64 70	"	4.7kΩ 1/6W	"	R113,114,159~162		
	HF 85 65 60	"	5.6kΩ 1/6W	"	R167,168		
	HF 85 66 80	"	6.8kΩ 1/6W	"	R115~118,123,124		
	HF 85 71 80	"	18kΩ 1/6W	"	R135,136		
	HF 85 74 70	"	47kΩ 1/6W	"	R157,158		
	HF 85 76 80	"	68kΩ 1/6W	"	R163,164		
	HF 85 78 20	"	82kΩ 1/6W	"	R111,112,125,126		
	HF 85 81 20	"	120kΩ 1/6W	"	R109,110		
	HF 85 81 50	"	150kΩ 1/6W	"	R133,134		
	HF 85 92 20	"	2.2MΩ 1/6W	"	R171,172		
	HL 32 41 00	Metal Oxide Film Resistor	10Ω 2W	酸化金抵抗	R101,102		
	HV 45 51 00	Flame Proof Carbon Resistor	100Ω 1/4W	不燃化カーボン抵抗	R139,140		
※	VC 23 66 00	Potentiometer	250kΩ MN	可変抵抗器	VR102 BALANCE		
※	VC 23 67 00	"	300kΩ X2	"	VR101 LOUDNESS		
※	VC 36 98 00	"	60kΩ (Y)X2	"	VR103 VOLUME		
	IA 09 70 00	Transistor	2SA970(GR,BL)	トランジスター	Q101~104		
	IF 00 34 50	Diode	1SS133	ダイオード	D101,102		
	IX 60 80 20	Zener Diode	MTZ 6.2B	ツェナーダイオード	D103		
	IF 00 87 30	LED	SLR-34URC3H3	L E D	D104~112		
	IG 09 20 00	IC	M5220L	I C	IC101		
※	VC 78 11 00	Remote Switch		リモートスイッチ	SW102 REC OUT		
※	VC 17 67 00	Push Switch	4-2NS	プッシュスイッチ	SW104,105 Muting/CD Direct		
※	VC 23 56 00	"	7	"	SW103 Input Selector		
※	VC 23 61 00	"	2-2S	"	SW107 Subsonic Filter		
※	VC 24 55 00	"	2-2NS	"	SW105 Mode		
※	VC 36 99 00	"	6-2	"	SW101 Phono		
	LB 20 22 90	Pin Jack	2P	ピンジャック	PJ101		
	LB 40 10 30	"	4P	"	PJ103~106		
	LB 60 60 90	"	6P	"	PJ102		
	VA 72 55 00	Parallel Holder	5P	バラレルホルダー			
	VA 72 57 00	"	7P	"			
	VA 72 58 00	"	8P	"			
	VA 72 59 00	"	9P	"			
	VA 72 62 00	"	12P	"			

※New Parts (新規部品)

AX-700/700U

MECHANISM EXPLODED VIEW

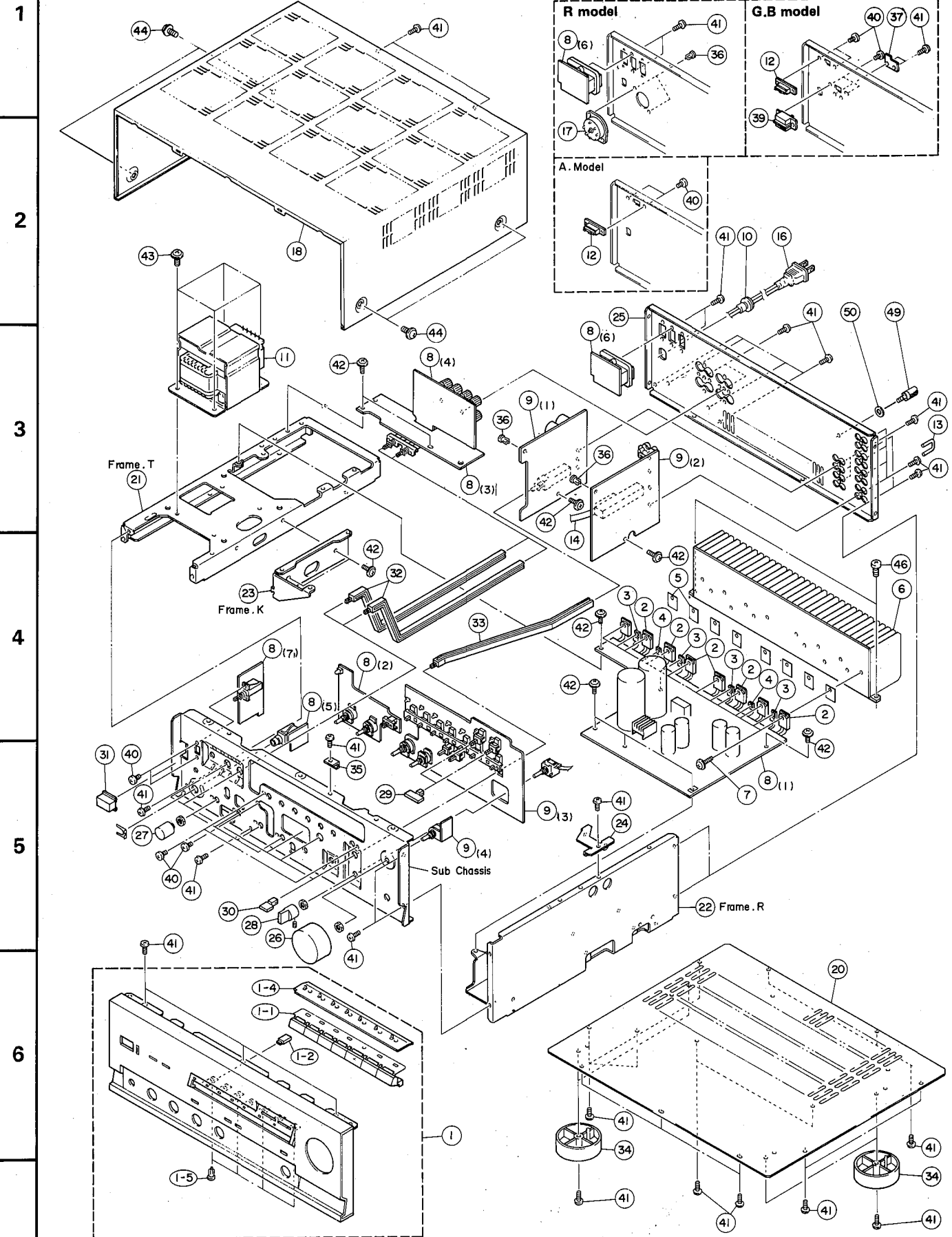

MECHANISM PARTS

Ref. No.	Part No.	Description	部品名	Remarks	Common Model	Markets	ランク
※ 1	VD 09 48 00	Panel Unit	パネルユニット	Silver		R,A,G,B	
※ "	VD 09 49 00	"	"	Silver		U,C	
※ "	VD 09 50 00	"	"	Black		R,A,G,B	
※ "	VD 09 51 00	"	"	Black		U,C	
1-1	NE 63 99 90	Button Ass'y	ボタン Ass'y	Silver			
"	NE 64 00 00	"	"	Black			
1-2	CB 66 07 40	Lens	レンズ				
1-3	CB 66 07 50	Lens	レンズ				
1-4	AA 63 17 10	Frame SW	フレーム S W				
1-5	CB 60 56 20	Plastic Rivet	プラスチックリベット				
2	IX 60 91 90	Pair Transistor	ペアトランジスタ	Q329, 330, 333, 334			
"	IX 60 92 00	"	"	Q327, 328, 331, 332			
3	IX 60 81 50	Pair Transistor	ペアトランジスタ	Q325, 326			
"	IX 60 81 60	"	"	Q323, 324			
4	VC 39 81 00	Transistor	トランジスタ	Q315, 316			
5	VB 43 50 00	Insulation Base	放熱シート				
6	BA 09 67 30	Radiator	ラジエター				
7	EX 60 02 50	Cup Screw	3×10 FCM3-BI カップタイトネジ				
※ 8	NA 09 42 80	Main Circuit Board	メインシート			R	
※ "	NA 09 42 90	"	"			U,C	
※ "	NA 09 43 00	"	"			A	
※ "	NA 09 43 10	"	"			G,B	
※ 9	NA 09 43 20	Function Circuit Board	ファンクションシート			R,U,A,C	
※ "	NA 09 43 30	"	"			G,B	
10	CB 62 01 90	Cord Stopper	CM-22B コードストッパー			R,A,G,B	
"	CB 62 02 00	"	CM-22C			U,C	
※ 11	XC 27 70 01	Power Transformer	電源トランス			R	
※ "	XC 27 80 01	"	"			U	
※ "	XC 27 90 01	"	"			A	
※ "	XC 28 00 01	"	"			G,B	
※ "	XC 28 10 01	"	"			C	
12	LA 00 29 50	Terminal Board	2P 中継端子台			A,G,B	
13	LB 10 11 10	Short Plug	ショートプラグ				
※ 14	VC 40 03 00	Wire, Remote SW	リモートSWワイヤー部				
16	MG 00 16 20	Power Cord	2.5A 250V 2m 電源コード	Inter changeable		G	
"	MG 00 23 20	"	2.5A 250V 2m	"		"	
"	MG 00 16 30	"	6A 250V 2m	"		R	
"	MG 00 09 20	"	7.5A 250V 2.5m	Inter changeable		A	
"	MG 00 23 10	"	7.5A 250V 2m	"		"	
"	MG 00 22 20	"	10A 125V1.98m	"		U,C	
"	MG 00 18 60	"	2.5A 250V 2m	"		B	
17	LB 20 14 80	Voltage Selector	電圧切換器				
39	KA 40 12 60	Slide Switch	5A/40A SS-12 スライドスイッチ	VOLTAGE SELECTOR			
18	AA 63 16 30	Top Cover	トップカバー	Silver			
19	AA 63 16 40	"	"	Black			
20	AA 63 16 20	Bottom Cover	ボトムカバー				
21	AA 63 16 00	Frame T	フレーム (T)				
22	AA 63 16 10	Frame R	フレーム (R)				
23	AA 63 17 30	Frame K	フレーム (K)				
24	AA 63 22 60	Support Sheet	サポートシート				
※ 25	AA 63 22 70	Rear Panel	リヤパネル			R	
※ "	AA 63 22 80	"	"			U,C	

※ New Parts (新規部品)

Parts List for Carbon Resistor

Value	1/4W Type Part No.	1/6W Type Part No.	Value	1/4W Type Part No.	1/6W Type Part No.
1.0 Ω	HJ353100	※	12K Ω	HJ357120	HF857120
1.8 "	HJ353180	※	15 "	HJ357150	HF857150
2.2 "	HJ353220	HF853220	18 "	HJ357180	HF857180
3.3 "	HJ353330	HF853330	22 "	HJ357220	HF857220
4.7 "	HJ353470	HF853470	27 "	HJ357270	HF857270
5.6 "	HJ353560	HF853560	33 "	HJ357330	HF857330
10 "	HJ354100	HF854100	39 "	HJ357390	HF857390
15 "	HJ354150	HF854150	47 "	HJ357470	HF857470
22 "	HJ354220	HF854220	56 "	HJ357560	HF857560
27 "	HJ354270	HF854270	68 "	HJ357680	HF857680
33 "	HJ354330	HF854330	82 "	HJ357820	HF857820
39 "	HJ354390	HF854390	91 "	HJ357910	HF857910
47 "	HJ354470	HF854470	100 "	HJ358100	HF858100
56 "	HJ354560	HF854560	120 "	HJ358120	HF858120
68 "	HJ354680	HF854680	150 "	HJ358150	HF858150
82 "	HJ354820	HF854820	180 "	HJ358180	HF858180
100 "	HJ355100	HF855100	220 "	HJ358220	HF858220
110 "	HJ355110	HF855110	270 "	HJ358270	HF858270
120 "	HJ355120	HF855120	330 "	HJ358330	HF858330
150 "	HJ355150	HF855150	390 "	HJ358390	HF858390
160 "	HJ355160	※	470 "	HJ358470	HF858470
180 "	HJ355180	HF855180	560 "	HJ358560	HF858560
220 "	HJ355220	HF855220	680 "	HJ358680	HF858680
270 "	HJ355270	HF855270	820 "	HJ358820	HF858820
330 "	HJ355330	HF855330	1.0M Ω	HJ359100	HF859100
390 "	HJ355390	HF855390	1.2 "	HJ359120	※
470 "	HJ355470	HF855470	1.5 "	HJ359150	HF859150
510 "	※	HF855510	1.8 "	HJ359180	HF859180
560 "	HJ355560	HF855560	2.2 "	HJ359220	HF859220
680 "	HJ355680	HF855680	3.3 "	HJ359330	HF859330
820 "	HJ355820	HF855820	3.9 "	HJ359390	※
910 "	HJ355910	HF855910	4.7 "	HJ359470	※
1.0K Ω	HJ356100	HF856100			
1.2 "	HJ356120	HF856120			
1.5 "	HJ356150	HF856150			
1.8 "	HJ356180	HF856180			
2.0 "	HJ356200	HF856200			
2.2 "	HJ356220	HF856220			
2.4 "	HJ356240	HF856240			
2.7 "	HJ356270	HF856270			
3.0 "	HJ356300	HF856300			
3.3 "	HJ356330	HF856330			
3.6 "	HJ356360	HF856360			
3.9 "	HJ356390	HF856390			
4.7 "	HJ356470	HF856470			
5.1 "	HJ356510	HF856510			
5.6 "	HJ356560	HF856560			
6.8 "	HJ356680	HF856680			
8.2 "	HJ356820	HF856820			
9.1 "	HJ356910	HF856910			
10 "	HJ357100	HF857100			

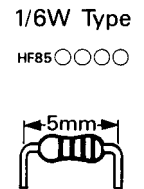
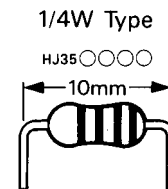

AX-700/700U

PRINTED CIRCUIT BOARD (Pattern Side) (Note) 文字面: Component Side

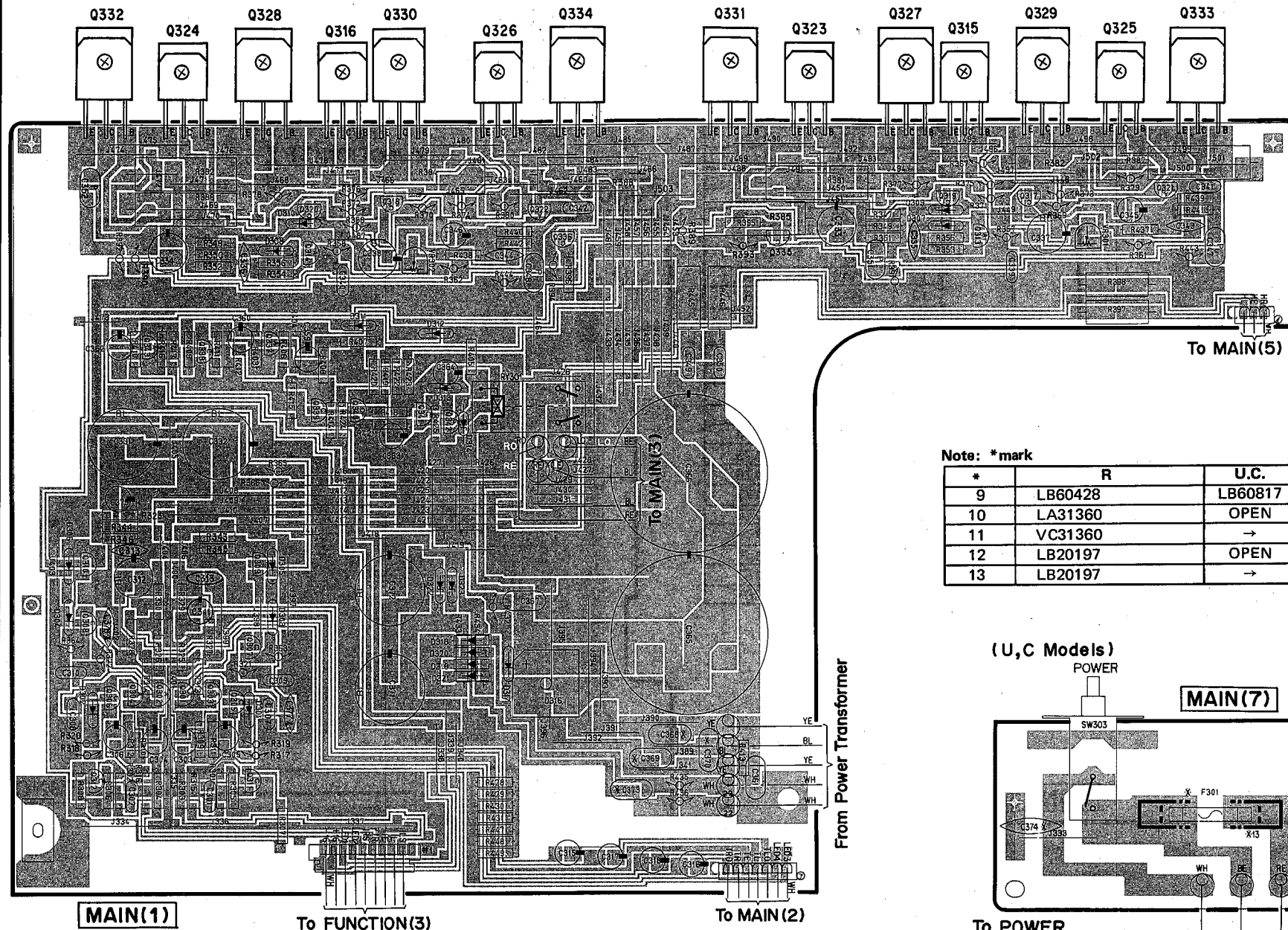

Note: *mark

*	R	U.C.	A	G.B
9	LB60428	LB60817	OPEN	→
10	LA31360	OPEN	→	→
11	VC31360	→	→	VC72080
12	LB20197	OPEN	→	→
13	LB20197	→	LB20106	→

Note: *marked

	R.U.A.C	G.B
C127~138, 145~148	OPEN	220P
R141~156, 175~180, 183, 184	SHORT	220
L101, 102	SHORT	15μH
L103, 104	OPEN	470μH
R105, 106	33	4.7K
C161	OPEN	0.01
C139~144, 162, 163	OPEN	470P
R181	OPEN	4.7
C101, 102	OPEN	150P/100 P
C111, 112	1500P	2200P
R173, 174	SHORT	22
J129	OPEN	SHORT

Note: *marked

	R	U.C	A	G.B
C361, 368, 369, 373	OPEN	→	0.1/250	→
C370	0.1/250	→	OPEN	→
C353~358	OPEN	→	0.01	→
C377, 378	OPEN	→	150P	→
R401, 402, 413	OPEN	→	10	→
F301	10A250V	→	T4A250V	→
F302	T5A250V	OPEN	→	→
C374	-	-	-	○

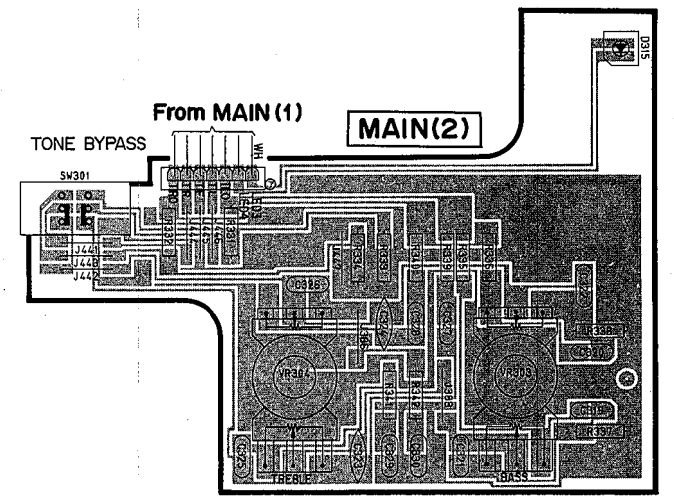

(R Model) POWER

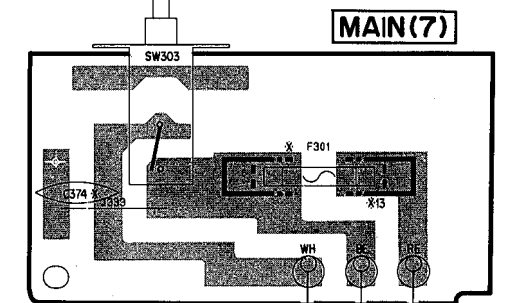

MAIN(7)

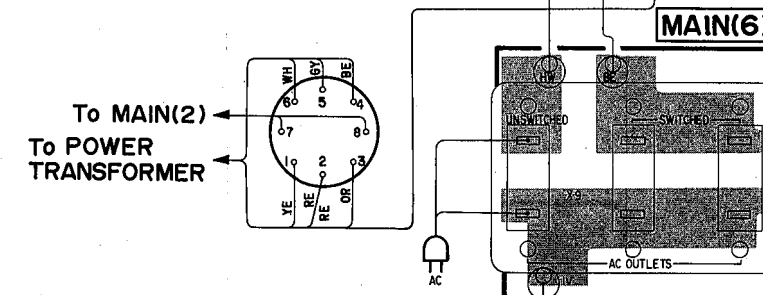

MAIN(6)

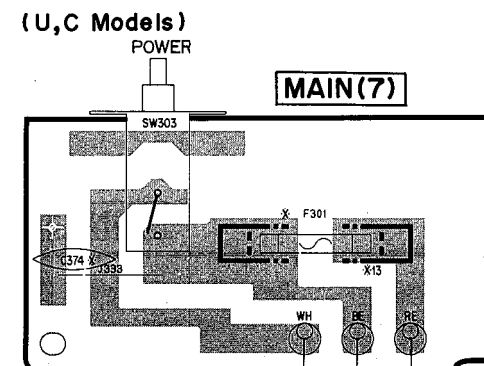

MAIN(7) (U,C Models)

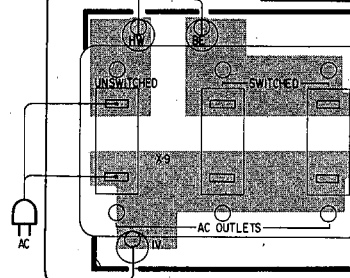

MAIN(6)

To POWER TRANSFORMER (A, G, B Models) POWER

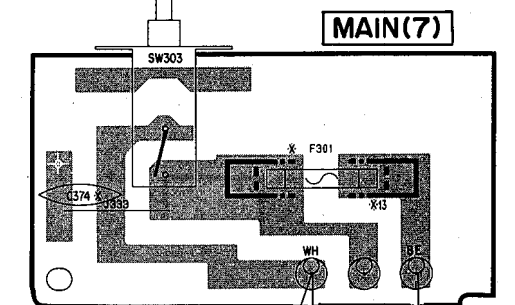

MAIN(7)

To POWER TRANSFORMER (A) (G, B)

To POWER TRANSFORMER

From AC CORD To POWER TRANSFORMER

6

7

8

9

AX-700/700U

PRINTED CIRCUIT BOARD (Pattern Side) (Note) 文字面 : Component Side

1
2
3
4
5
6
7

MAIN(5)

From MAIN(1)

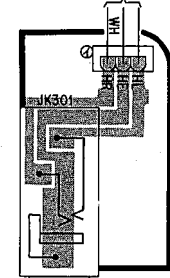

PHONES

MAIN(3)

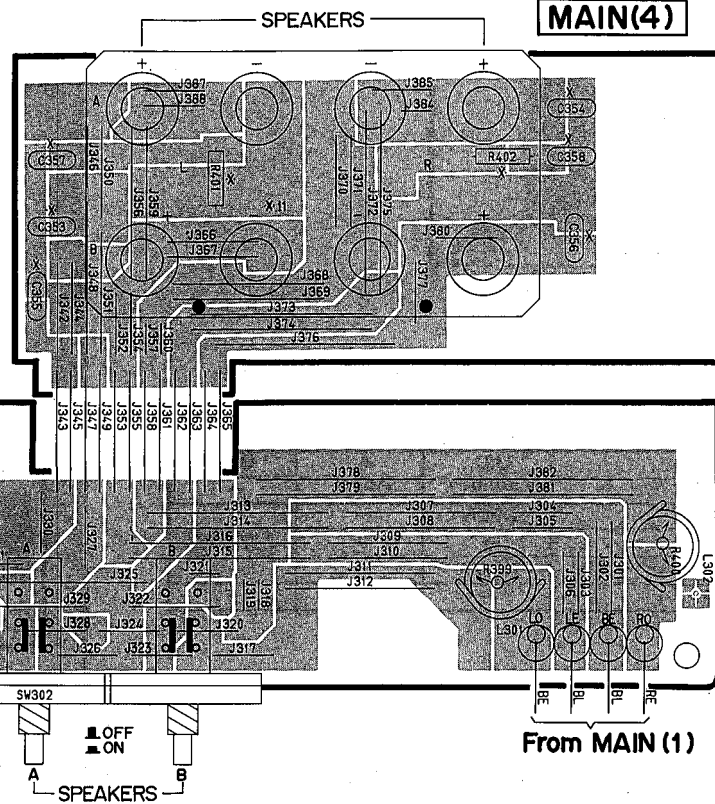
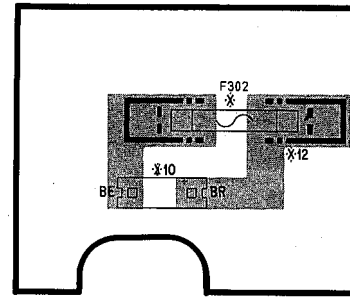

From MAIN(1)

FUNCTION(3)

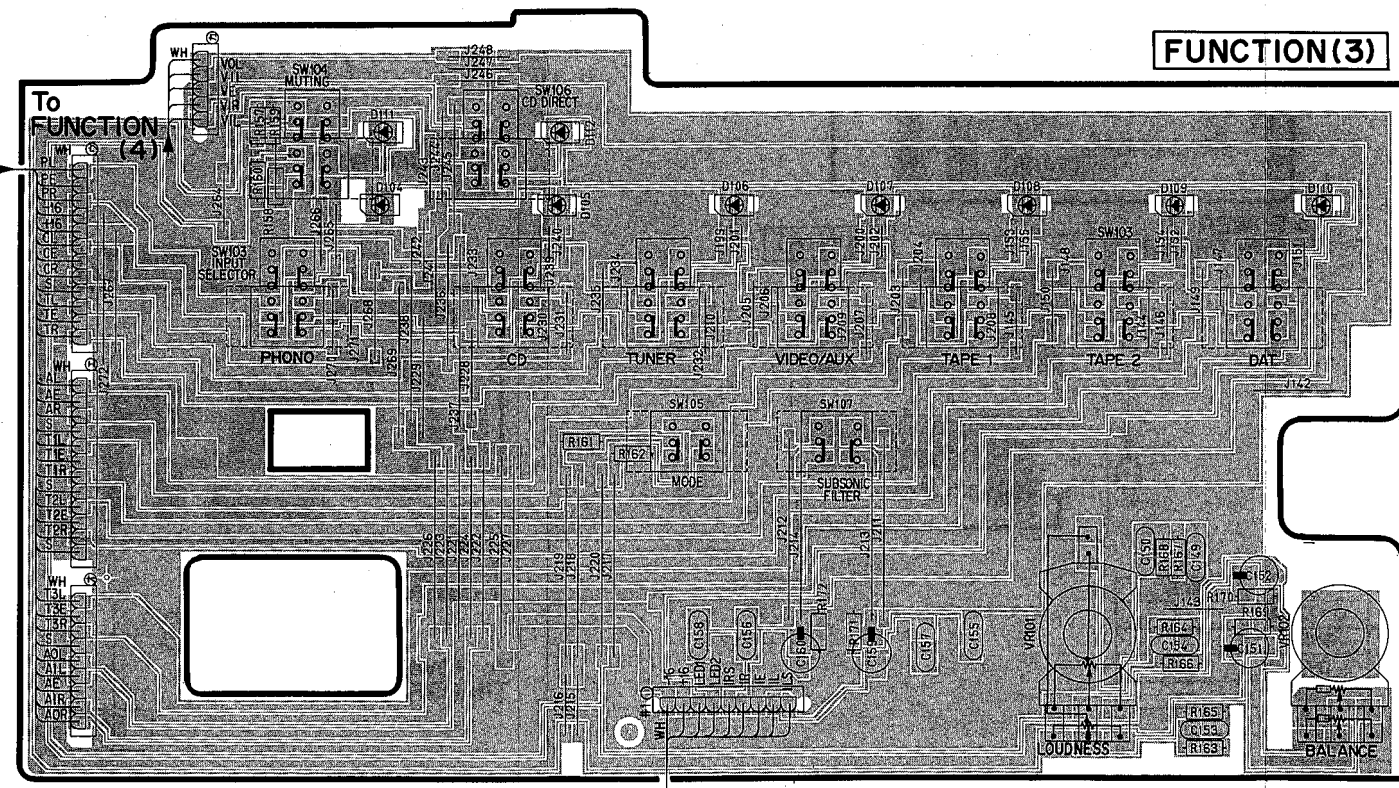

From FUNCTION(2)

To FUNCTION(4)

From MAIN(1)

Note: *marked

*	R.U.A.C	G.B.
1	J101	R141
2	J102	R142
3	J103	R143
4	J104	R144
5	J105	R145
6	J106	R146
7	J107	R147
8	J108	R148
9	J109	R149
10	J110	R150
11	J111	R151
12	J112	R152
13	J113	R153
14	J114	R154
15	J115	R155
16	J116	R156
17	J125	L102
18	J126	L101
19	J117	R173
20	J118	R174
21	J119	R175
22	J120	R176
23	J121	R177
24	J122	R178
25	J123	R179
26	J124	R130
27	J127	R183
28	J128	R184

FUNCTION(4)

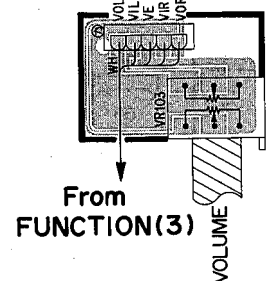

From FUNCTION(3)

VOLUME

FUNCTION(1)

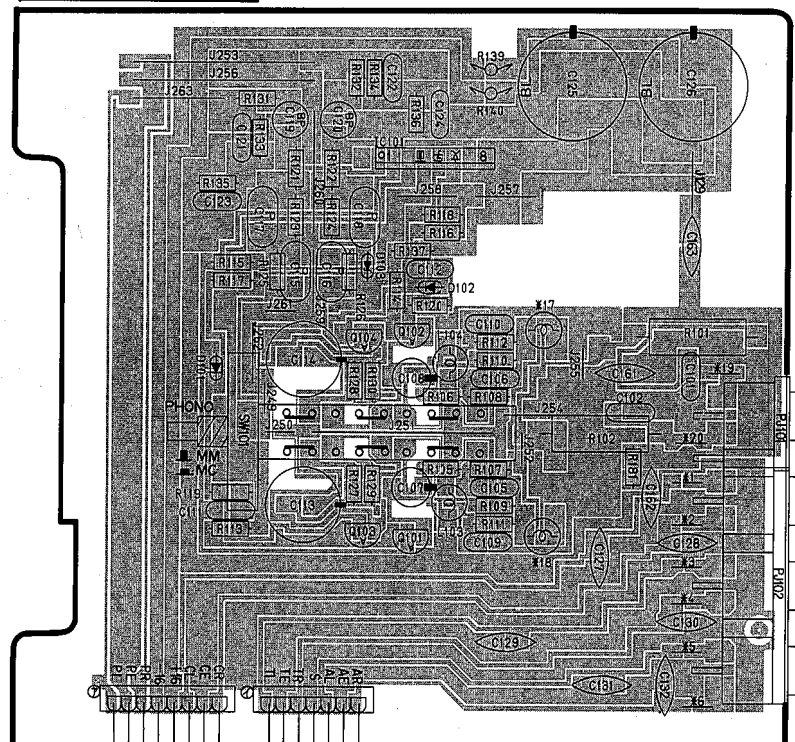

PHONO
CD
TUNER
VIDEO/AUX

FUNCTION(2)

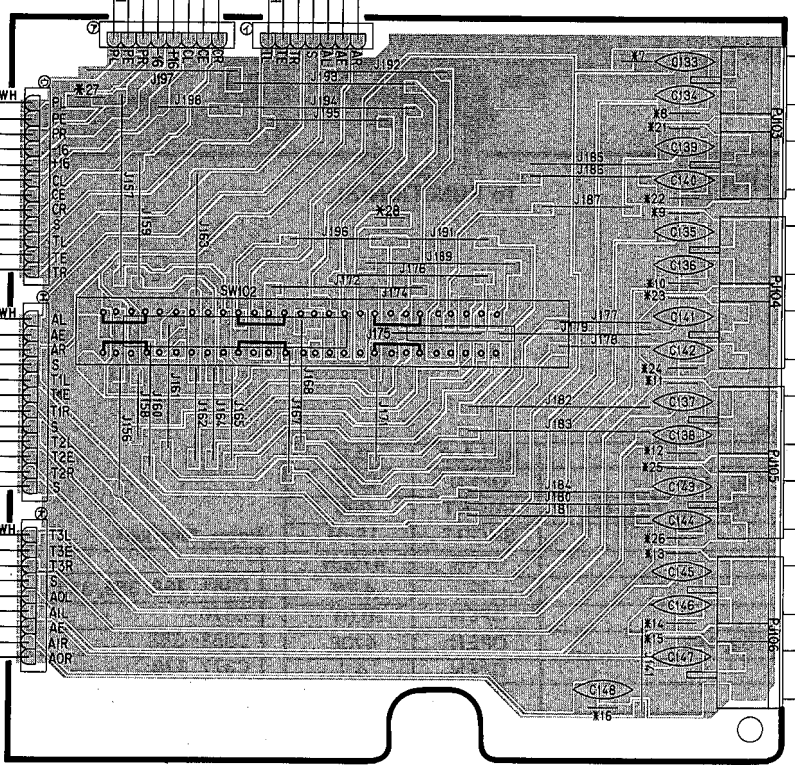

TAPE PB
TAPES 1
REC OUT
TAPE PB
TAPES 2
REC OUT
TAPE PB
DAT
REC OUT
SEND
ACCESSORY
RECEIVE

To FUNCTION(3)

SCHEMATIC DIAGRAM

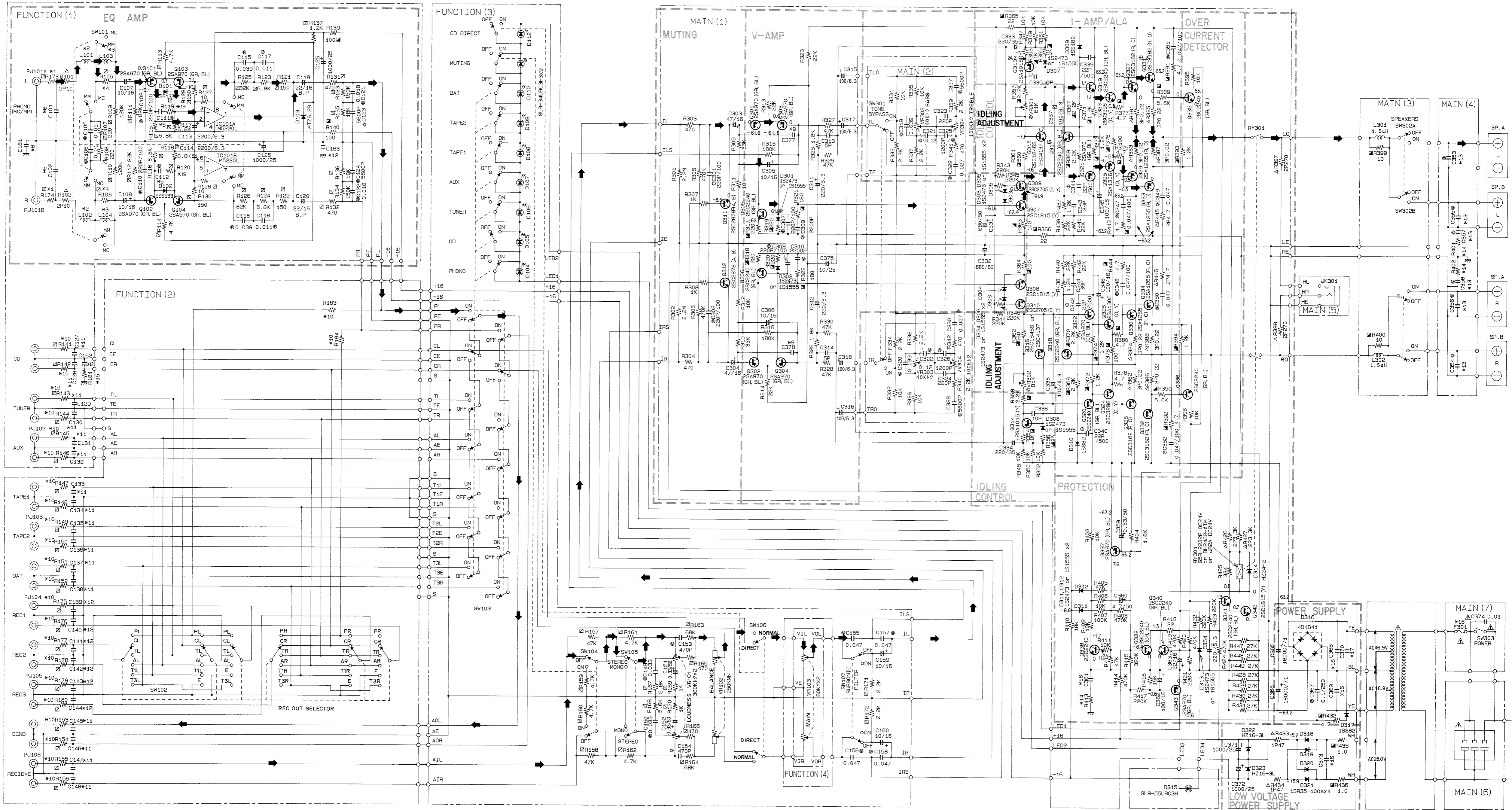

	R	U, C	A	B, G
*1	SHORT			22
*2	SHORT			15 uH
*3	OPEN			470 uH
*4	33			4.7K
*5	@1500P			@2700P
*6	OPEN			@150P/100
*8	OPEN			0.01
*9	OPEN			150P
*10	SHORT			220

	R	U, C	A	B, G
*11	OPEN			220P
*12	OPEN			470P
*13	OPEN			@ 0.01
*14	OPEN			10
*15	OPEN			4.7
*16	OPEN			0.1/250
*17	0.1/250			OPEN
*18	10A 250V			14.0A 250V
*19	100			180

REMARKS	PARTS NAME
□	CARBON FILM RESISTOR
▣	CARBON FILM RESISTOR (1/6W)
△	METAL OXIDE FILM RESISTOR
○	METAL FILM RESISTOR
⊠	METAL PLATE RESISTOR
▢	FIRE PROOF CARBON FILM RESISTOR
◻	SEMENT MOLDED RESISTOR
⊗	SEMI VARIABLE RESISTOR

REMARKS	PARTS NAME
□	ELECTROLYTIC CAPACITOR
○	CERAMIC CAPACITOR
⊙	POLYESTER FILM CAPACITOR
○	POLYSTYRENE FILM CAPACITOR
⊖	MICA CAPACITOR
⊕	POLYPROPYLENE FILM CAPACITOR
●	SEMICONDUCTIVE CERAMIC CAPACITOR

IC BLOCK

IC101: M5220L (Dual Low-Noise Pre-Amp.)

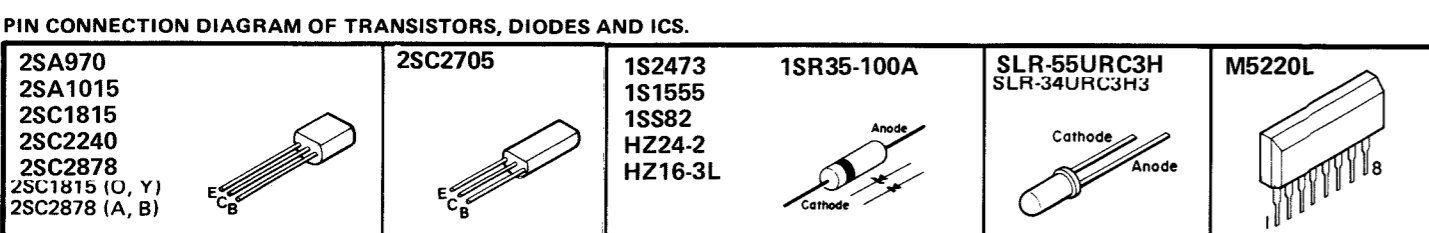

* All voltages are measured with a 10MΩ/DC electric volt meter.
 * Components having special characteristics are marked with a triangle and must be replaced with parts having specifications equal to those originally installed.
 * Schematic diagram is subject to change without notice.

■ BLOCK DIAGRAM

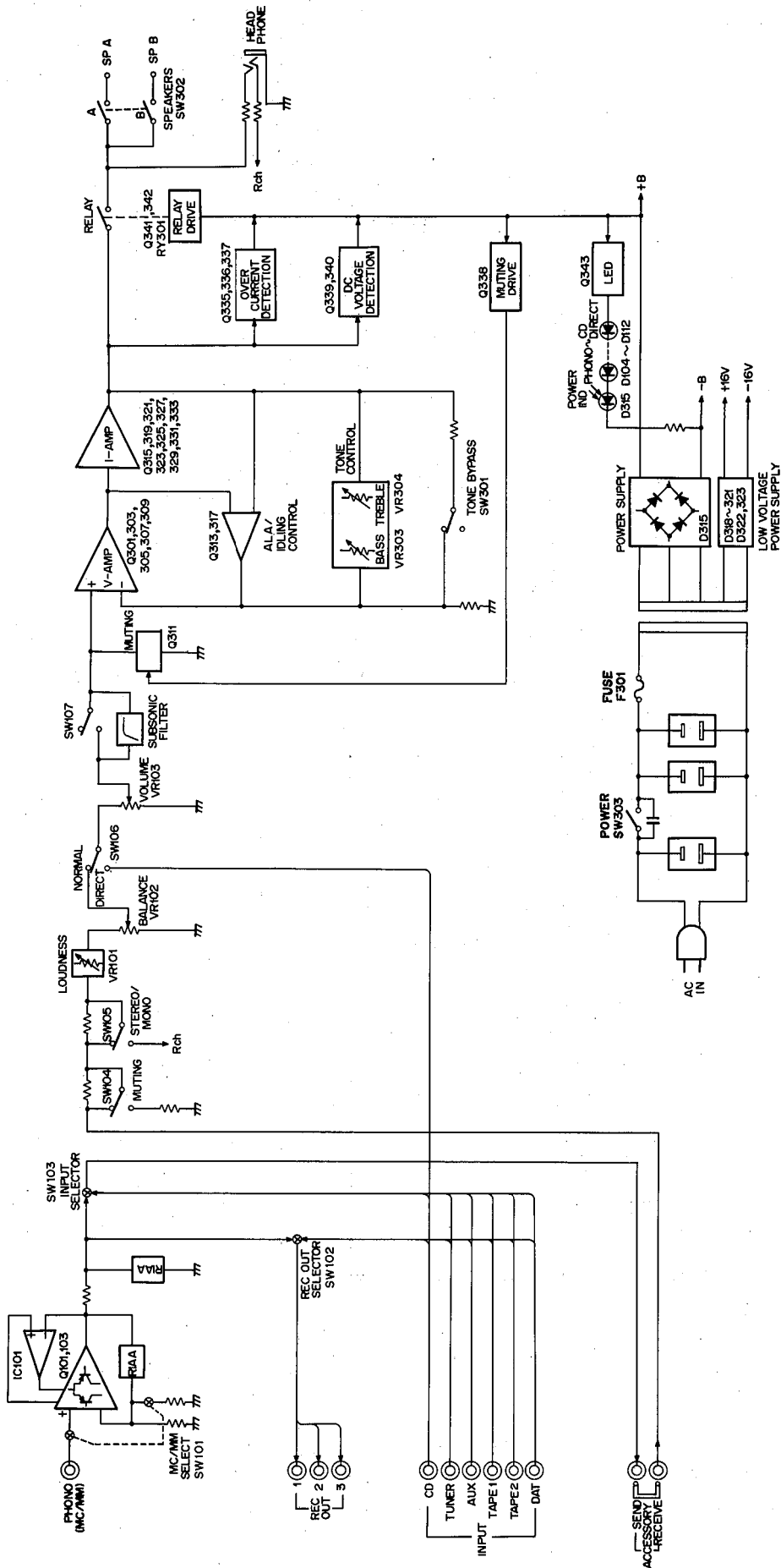

AX-700/700U

WIRING

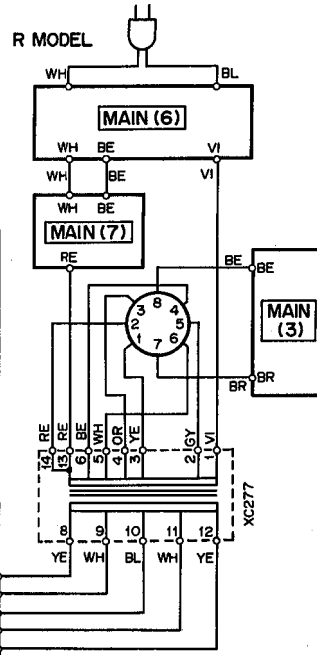
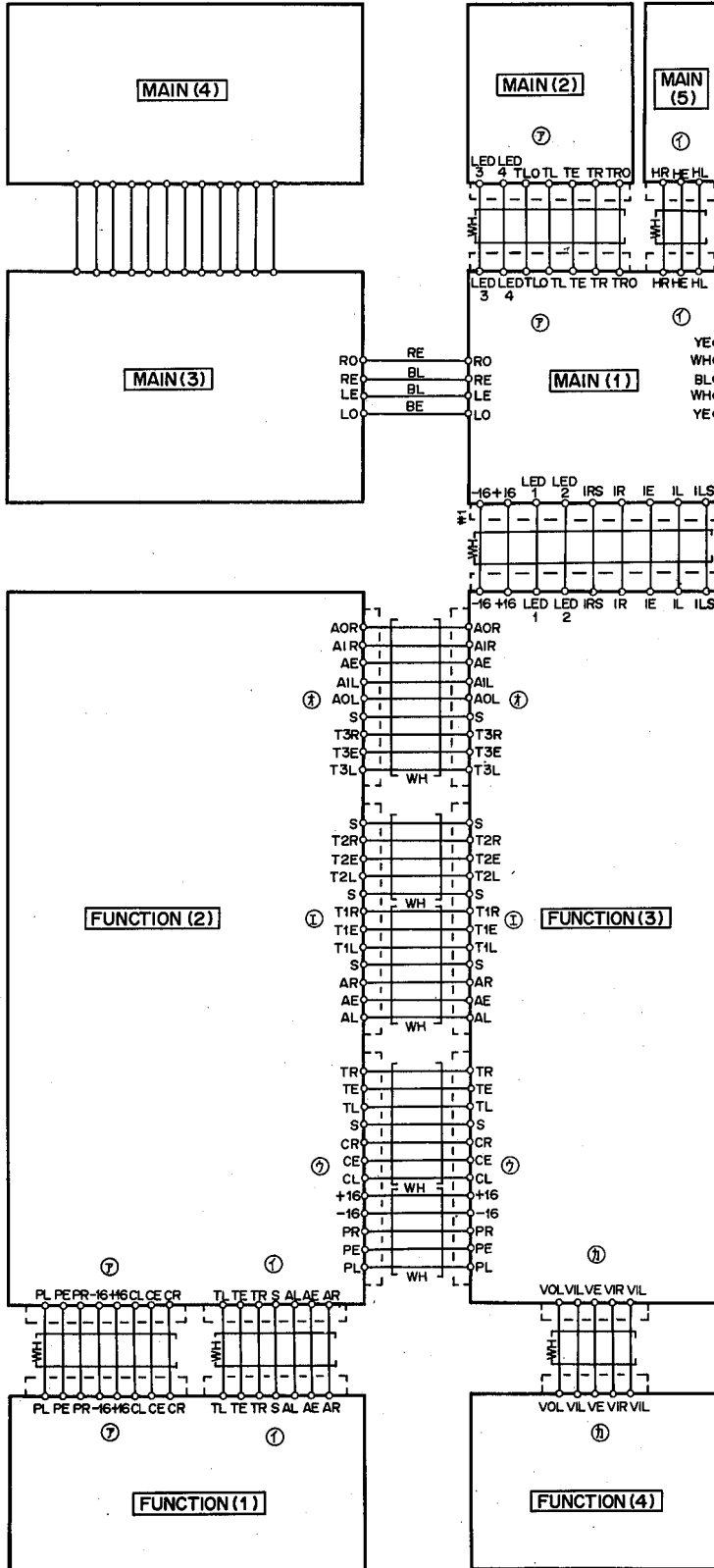

U,C MODELS

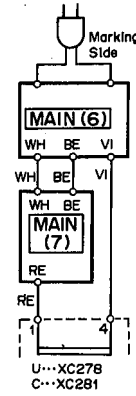

G,B MODELS

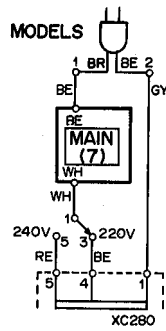

A MODEL

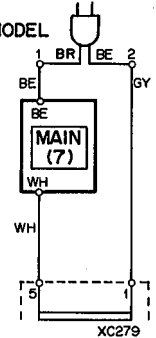

AX-700/700U